

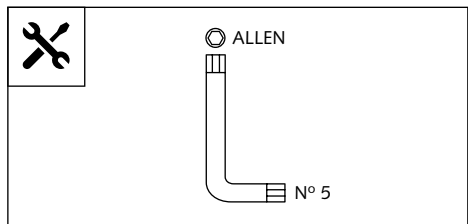

CÚPULA TOURING PARA - TOURING SCREEN FOR - TOURENSCHEIBE FÜR
BMW G310GS '17-



Ref.: 9879

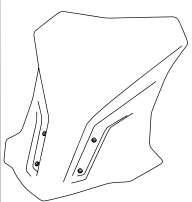

 1 persona 1 person	 15 min	Fácil - Easy
		Media-Intermediate
		Difícil-Difficult

ID	PIEZA / PART	DESCRIPCIÓN	DESCRIPTION	QTY	REF.
1		Cúpula Touring	Touring screen	1	9879H/F/WM3
2		Silentblock Ø12x Ø6 x9	Ø12x Ø6 x9 silentblock	4	AROPASACABLES-1
3		Casquillo con valona Ø12x Ø6,8 x7,3	Ø12x Ø6,8 x7,3 bush with flange	4	CASQUI-1A---750

CÚPULA TOURING PARA - TOURING SCREEN FOR - TOURENSCHEIBE FÜR
BMW G310GS '17-

INSTRUCCIONES DE MONTAJE - MOUNTING INSTRUCTIONS - MONTAGEANLEITUNG

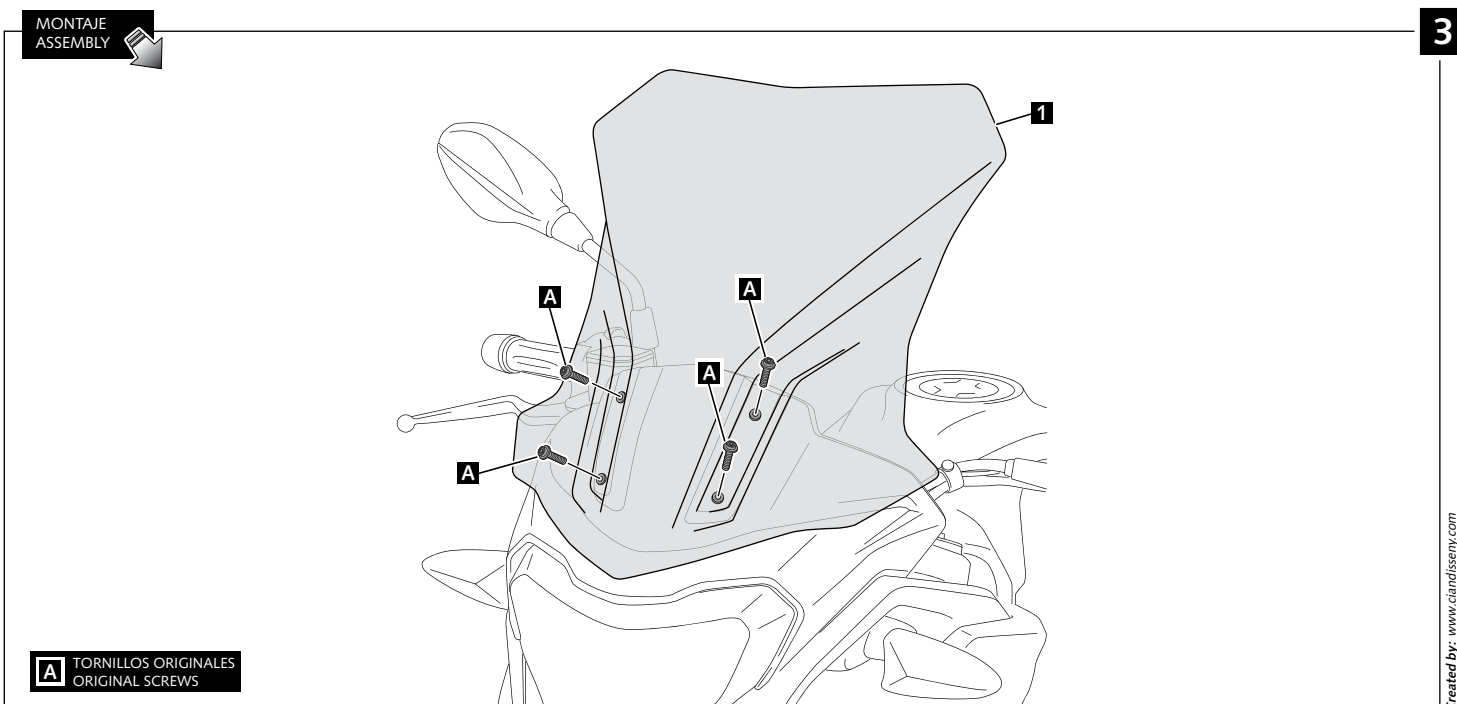
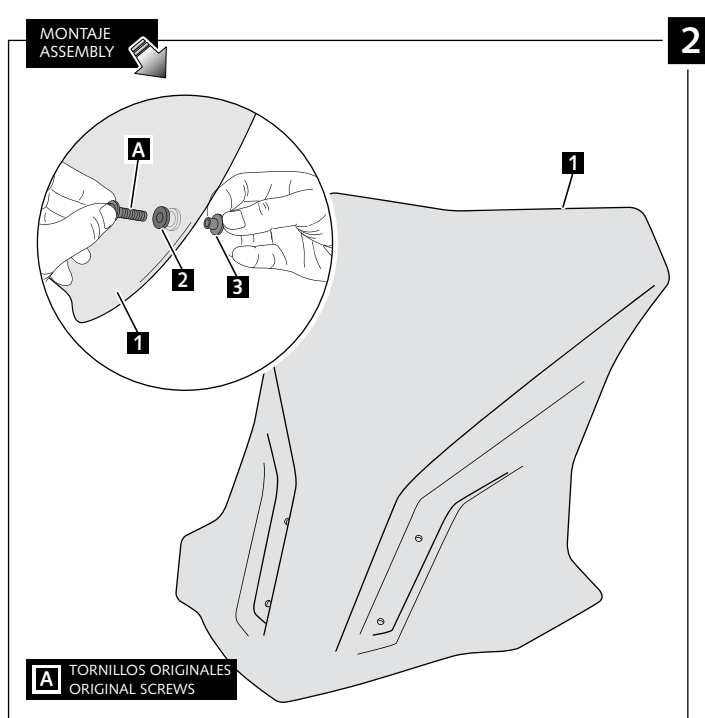
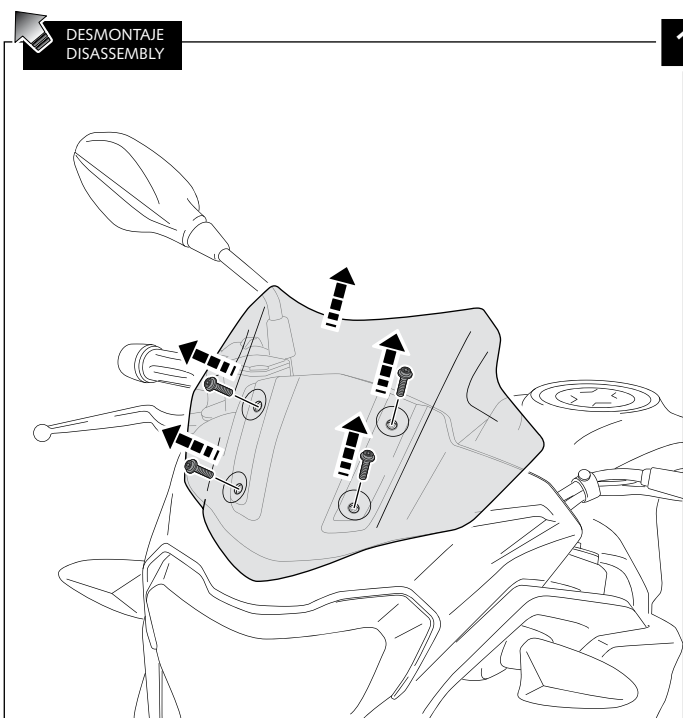

VISERA MULTIREGULABLE MULTI-ADJUSTABLE VISOR

CÚPULA TIPO
TYPE WINDSCREEN **A**



CÚPULA TIPO
TYPE WINDSCREEN **B**



CÚPULA TIPO
TYPE WINDSCREEN **C**



Ref.: 6007

Ref.: 5852

Ref.: 5853

Ahumado/Smoke

Transparente/Clear

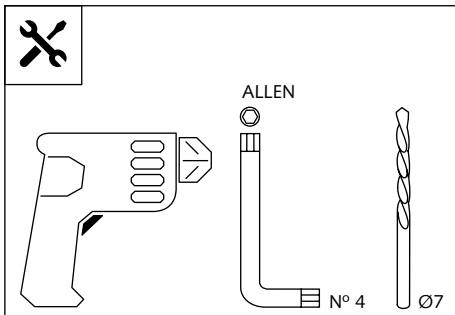

1 persona
1 person



15 min

Fácil - Easy





Media-Intermediate

Difícil-Difficult

Nota/Note:

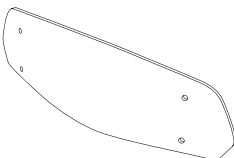
Si la visera se suministra con la cúpula Puig, no será necesario realizar los agujeros por que ya vienen incorporados.

If the visor is supplied along with the windscreen, the windscreen will come factory-drilled so no drilling is necessary.

ID.	PIEZA / PART	DESCRIPCIÓN	DESCRIPTION	QTY.
1		Visera	Visor	1
2		Plantilla	Template	1
3		Mecanismo multiregulable	Multi-adjustable mechanism	2
4		Tapeta	Cap	4
5		Tornillo rosca plástico M6x12	Plastic thread fastener M6x12	8

VISERA MULTIREGULABLE MULTI-ADJUSTABLE VISOR

INSTRUCCIONES DE MONTAJE - MOUNTING INSTRUCTIONS - MONTAGEANLEITUNG

TIPO/TYPER A - TIPO/TYPER A - TIPO/TYPER A

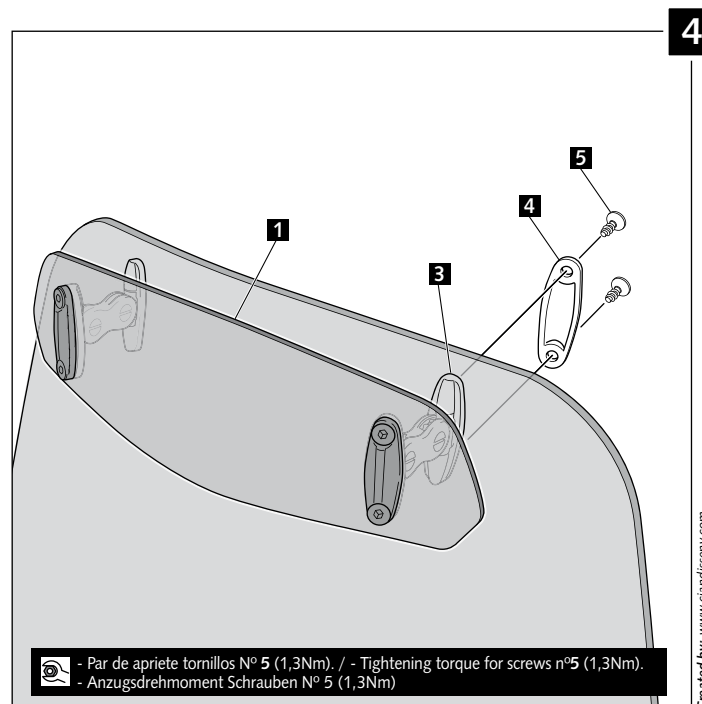
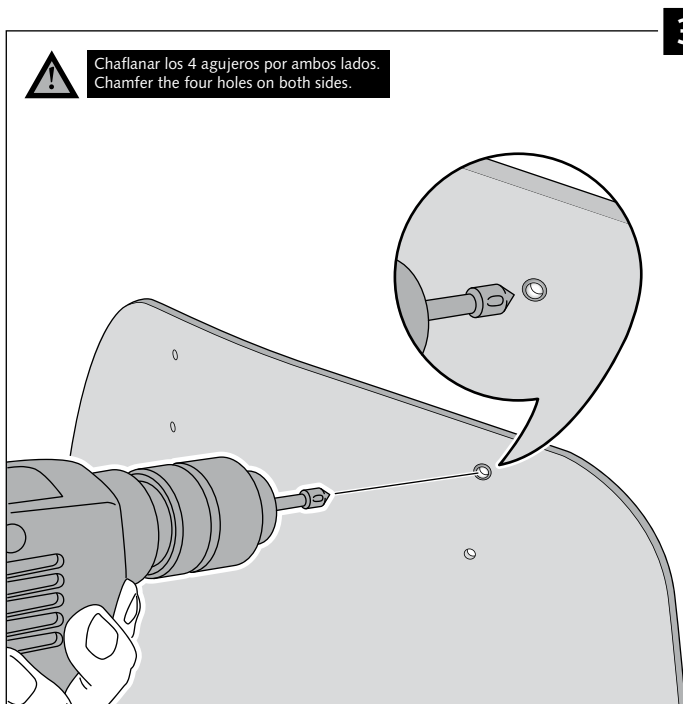
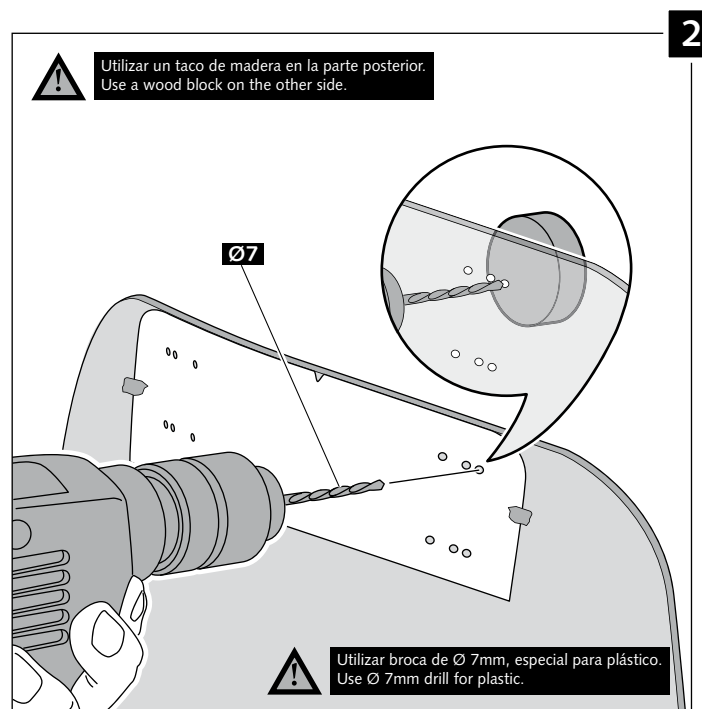
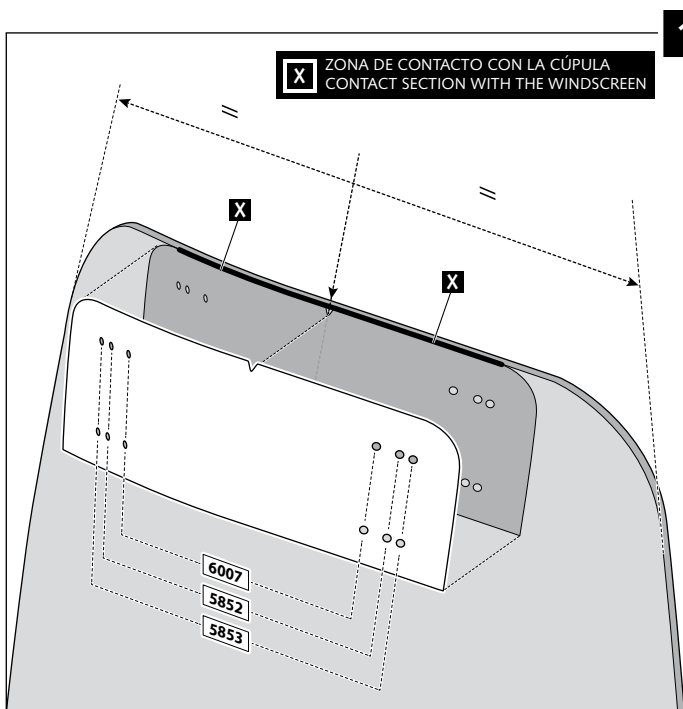

VISERA MULTIREGULABLE MULTI-ADJUSTABLE VISOR

INSTRUCCIONES DE MONTAJE - MOUNTING INSTRUCTIONS - MONTAGEANLEITUNG

TIPO/TYPER B - TIPO/TYPER B - TIPO/TYPER B

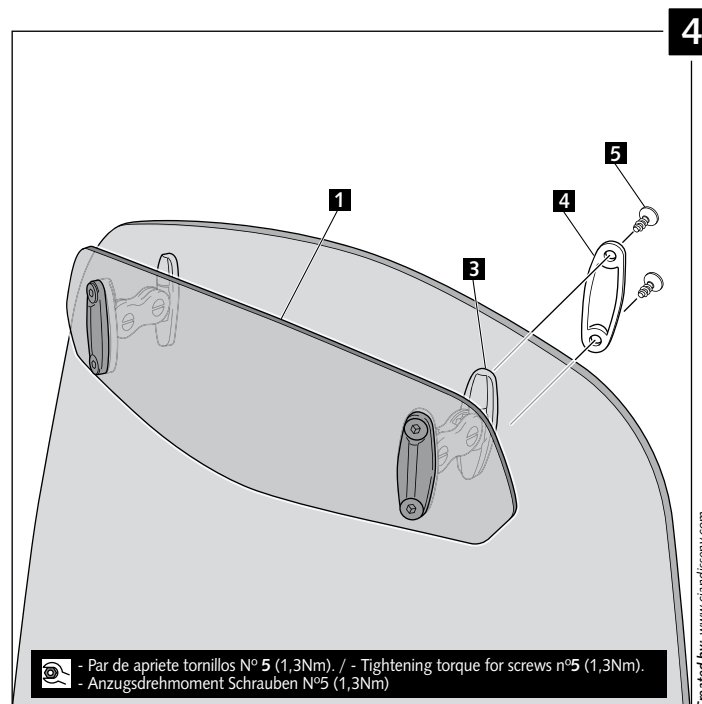
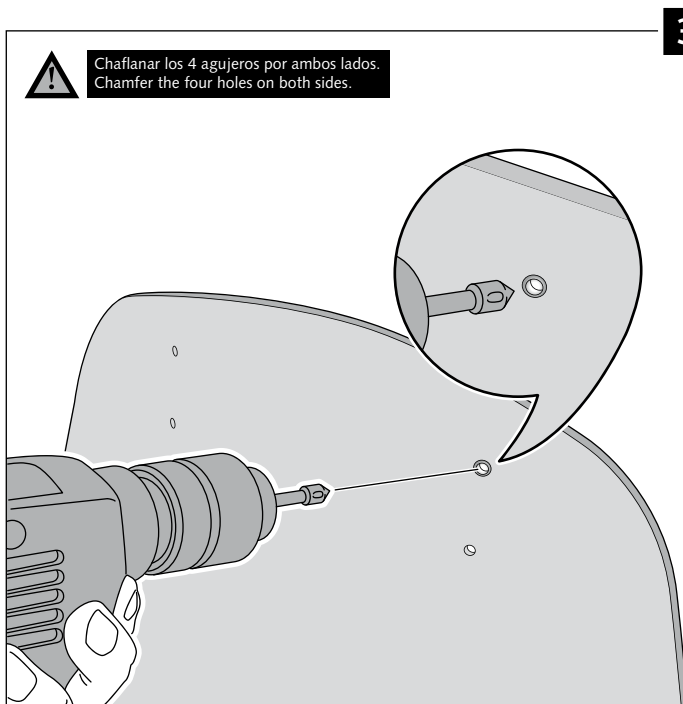
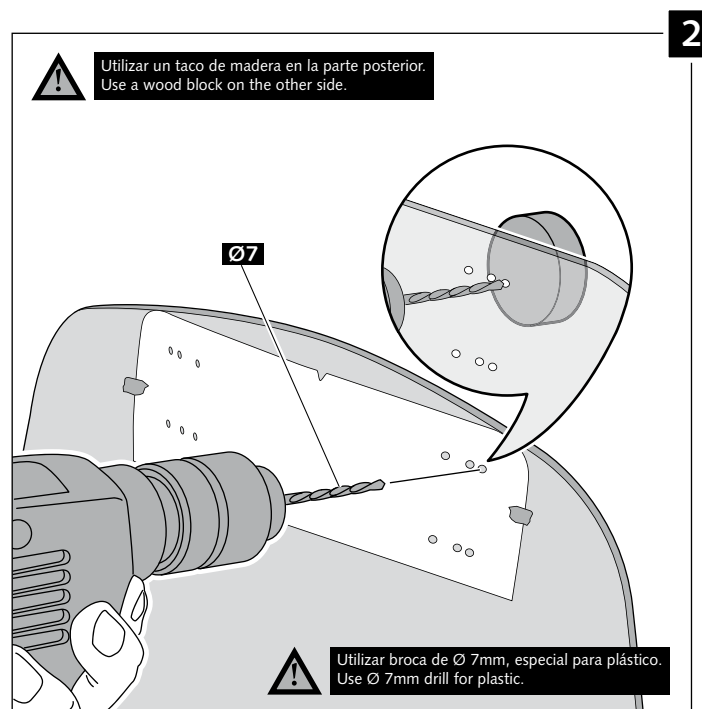
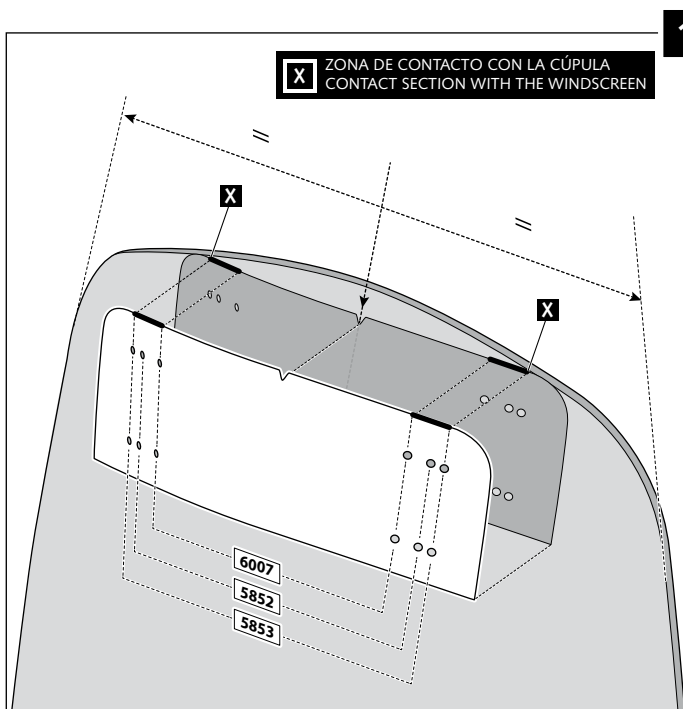

VISERA MULTIREGULABLE MULTI-ADJUSTABLE VISOR

INSTRUCCIONES DE MONTAJE - MOUNTING INSTRUCTIONS - MONTAGEANLEITUNG

TIPO/TYPER C - TIPO/TYPER C - TIPO/TYPER C

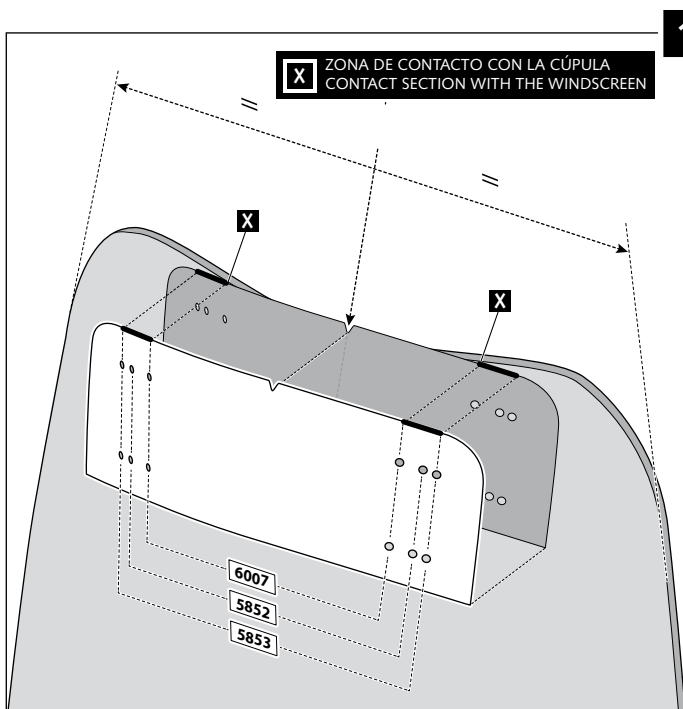

1

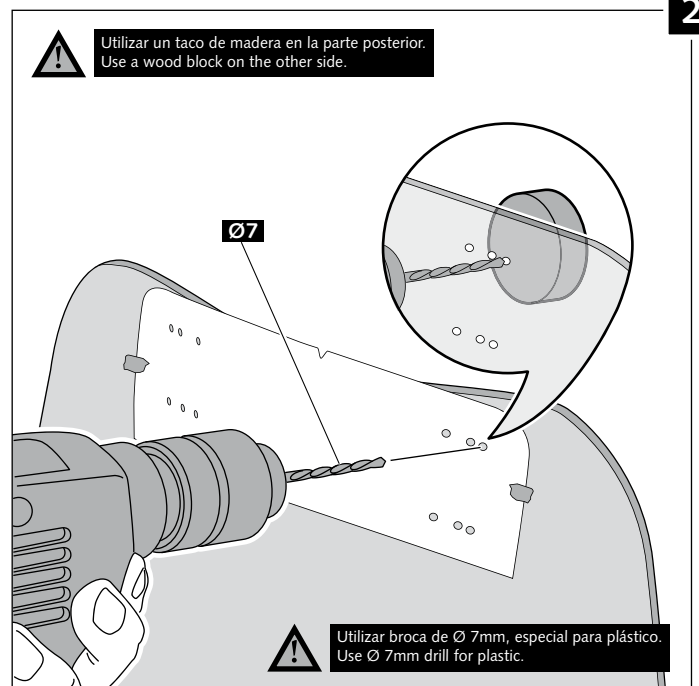

2

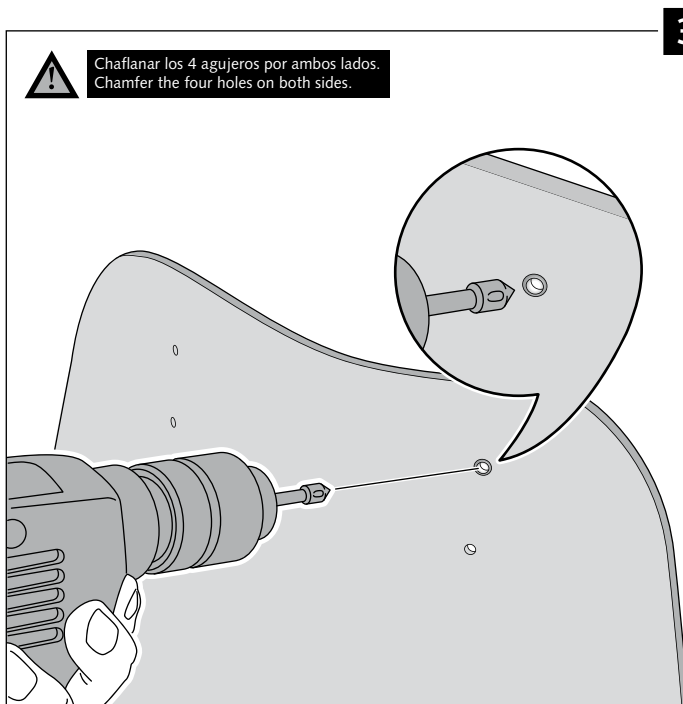

3

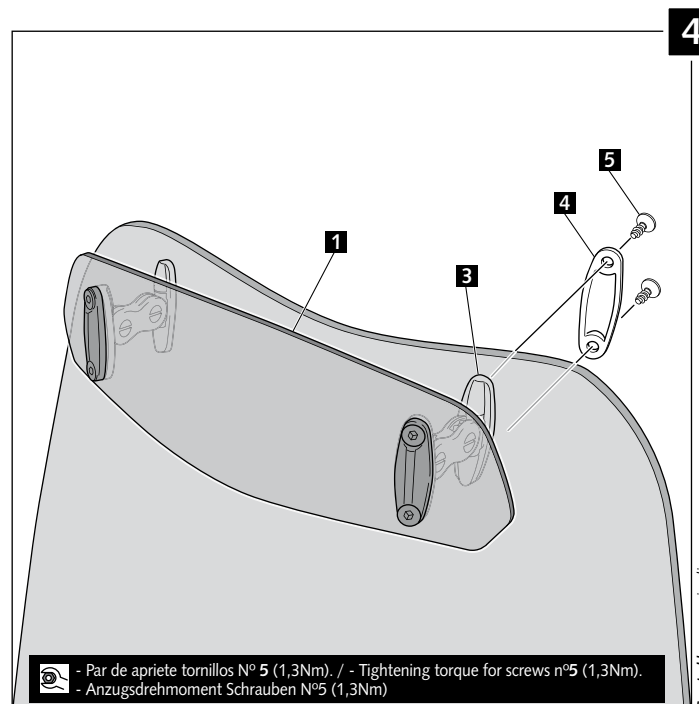

4