

C-Bow Taschenhalter / Soft bag holder

HONDA CB 500 F

ab Baujahr 2016
from date of manufacture 2016

Artikel Nr./Item-no.:

630996 00 05 anthrazit/anthracite

HONDA CBR 500 R

ab Baujahr 2016
from date of manufacture 2016

Artikel Nr./Item-no.:

630995 00 05 anthrazit/anthracite



Kombinierbar mit:
Combinable with:
Minirack
Alurack
Easyrack



DE WICHTIG
GB IMPORTANT

Die Voraussetzung für die Montage ist natürlich eine gewisse technische Erfahrung. Wenn Sie sich nicht sicher sind, wie man eine bestimmte Arbeit ausführt, sollten Sie diese Ihrer Fachwerkstatt überlassen. Ziehen sie alle zugänglichen Schrauben zuerst nur locker an. Nachdem alles montiert ist, werden die Schrauben dann auf das entsprechende Anzugsmoment festgezogen. Dadurch wird sichergestellt, dass das Produkt spannungsfrei angebaut ist. Anzugsmomente beachten! Nach der Montage alle Verschraubungen auf festen Sitz kontrollieren!

Of course, the assembly requires a certain technical experience. If you are not sure how to execute a determined action, you should ask your local distributor to do it. First, tighten all screws only loosely. After mounting all parts, the screws should be tightened to the torque specified. This guarantees, that the product is mounted without tension. Observe the tightening torques of the manufacturer! Control all screw connections after the assembling for tightness!

C-Bow Taschenhalter / Soft bag holder

HONDA CB 500 F

ab Baujahr 2016
from date of manufacture 2016

Artikel Nr./Item-no.:

630996 00 05 anthrazit/anthracite

HONDA CBR 500 R









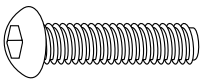
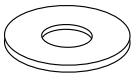
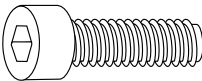

ab Baujahr 2016
from date of manufacture 2016

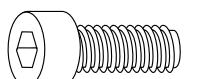
Artikel Nr./Item-no.:



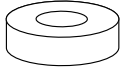

630995 00 05 anthrazit/anthracite

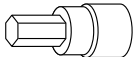
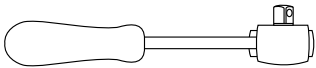
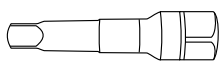

DE INHALT
GB CONTENTS

2x	70007063	C-Bow schwarz - C-Bow black			
1x	70009267	Halter vorne links - adapter front left			
1x	70009268	Halter vorne rechts - adapter front right			
1x	70009269	Halter hinten - rear holder			
1x	70009270	Halteplatte - holding plate			
1	70009271	Schraubensatz/Screw kit:			
	4x	Linsenkopfschraube M6x50 filister head screw M6x50		4x	Karoseriescheibe Ø6,4xØ18 body washer Ø6,4xØ18
	4x	Inbusschraube M8x40 allen screw M8x40		10x	U-Scheibe ø6,4 washer ø6,4
	2x	Inbusschraube M8x30 allen screw M8x30		2x	U-Scheibe ø6,4x3mm washer ø6,4x3mm
	8x	Sechskantschraube M6x16 hexagon bolt M6x16		8x	U-Scheibe ø8,4 washer ø8,4
	4x	Aludistanz Ø25xØ9x5mm alu spacer Ø25xØ9x5mm		4x	Selbstsichernde Mutter M6 self lock nut M6
	2x	Stahldistanz Ø18xØ14x22mm schwarz steel spacer Ø18xØ14x22mm black		2x	Selbstsichernde Mutter M8 self lock nut M8

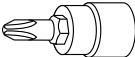
DE BENÖTIGTE WERKZEUGE
GB TOOLS REQUIRED

	Inbusschlüssel Allen key 4/5/6/8		Ratsche Ratchet		Verlängerung Extension
	Gabel-Ringschlüssel Wrench 10+13		Kreuzschlitznuss Phillips nut		Nuss/nut 10

C-Bow Taschenhalter / Soft bag holder

HONDA CB 500 F

ab Baujahr 2016
from date of manufacture 2016

Artikel Nr./Item-no.:

630996 00 05 anthrazit/antracite

HONDA CBR 500 R

ab Baujahr 2016
from date of manufacture 2016

Artikel Nr./Item-no.:

630995 00 05 anthrazit/antracite



DE VORBEREITUNG
GB PREPARING

1 Soziussitz entfernen und die vier Originalschrauben entfernen, diese entfallen. Kennzeichenhalterung absenken. Die beiden Schrauben der unteren, inneren Kunststoffabdeckung entfernen und das obere Stück abtrennen, dieses entfällt. Abdeckung wieder festschrauben. Mit den vier Linsenkopfschrauben M6x50 und Karosseriescheiben $\text{\O}6,4 \times \text{\O}18$ von oben den Kennzeichenhalter wieder befestigen. Die hinteren Schrauben noch nicht ganz eindrehen !

Dismantle pillion seat and the four original screws - screws are obsolete. Lower the number plate holder. Remove the two screws of the lower plastic cover at the inside and disconnect the upper piece, this is obsolete. Mount the lower cover again. Mount the number plate holder again with the four filister head screws M6x50 with body washers $\text{\O}6,4 \times \text{\O}18$. Do not fully screw in the rear screws yet.

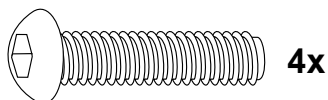

4x

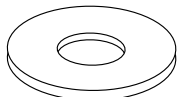

1

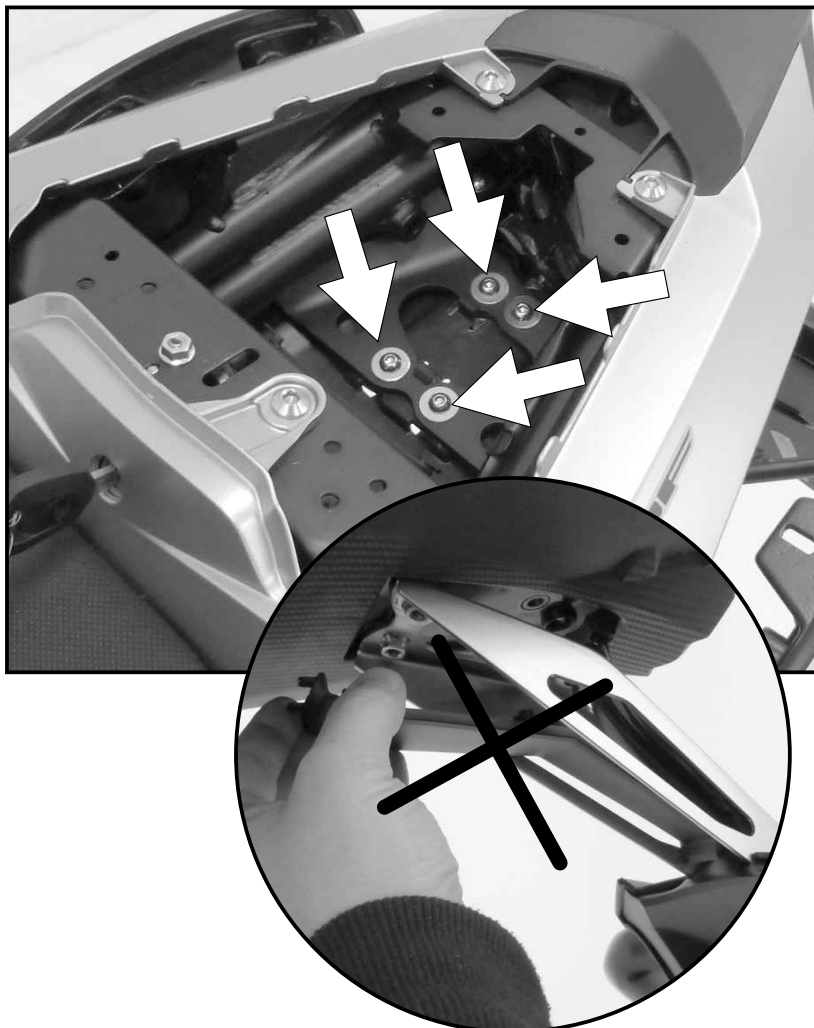

Montage Halteplatte hinten:

Die Montage erfolgt an den bereits montierten hinteren Schrauben mit den U-Scheiben $\text{\O}6,4$ sowie den selbstsichernden Muttern M6. Zwischen Halteplatte und Kennzeichenhalterung die Stahldistanzen $\text{\O}18 \times \text{\O}14 \times 22 \text{mm}$ fügen.

Fastening of the holding plate rear:

At the already mounted rear allen screws. To secure, use washers $\text{\O}6,4$ with self lock nuts M6.

Add steel spacer $\text{\O}18 \times \text{\O}14 \times 22 \text{mm}$ between holding plate and number plate holder.

2

Fahrtrichtung driving direction

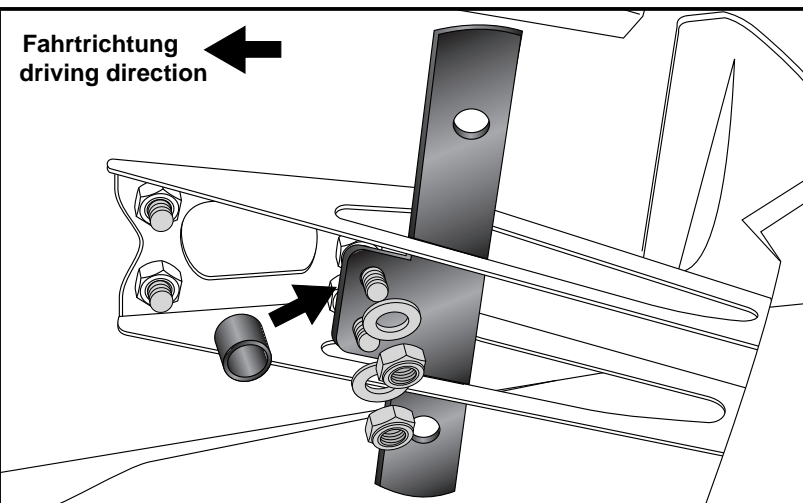

2x

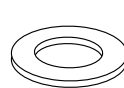

2x



2x

C-Bow Taschenhalter / Soft bag holder

HONDA CB 500 F

ab Baujahr 2016
from date of manufacture 2016

Artikel Nr./Item-no.:

630996 00 05 anthrazit/anthracite

HONDA CBR 500 R

ab Baujahr 2016
from date of manufacture 2016

Artikel Nr./Item-no.:

630995 00 05 anthrazit/anthracite



DE MONTAGEANLEITUNG
GB MOUNTING INSTRUCTIONS

Montage Halter hinten:

VORNE ①

Die Montage erfolgt an den bereits montierten vorderen Schrauben mit den U- Scheiben Ø6,4x3mm sowie den selbstsichernden Muttern M6.

HINTEN ②

An der Halteplatte von unten mit den Inbusschrauben M8x30, den U- Scheiben Ø8,4 sowie den selbstsichernden Muttern M8 verschrauben.

Fastening of the rear holder:

FRONT ①

At the already mounted front allen screws together. To secure, use washers ø6,4x3mm with self lock nuts M6.

REAR ②

At the holding plate. Use allen screws M8x30, washers Ø8,4 and self lock nuts M8.

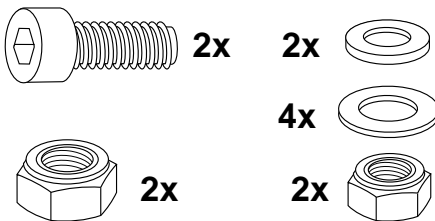

3

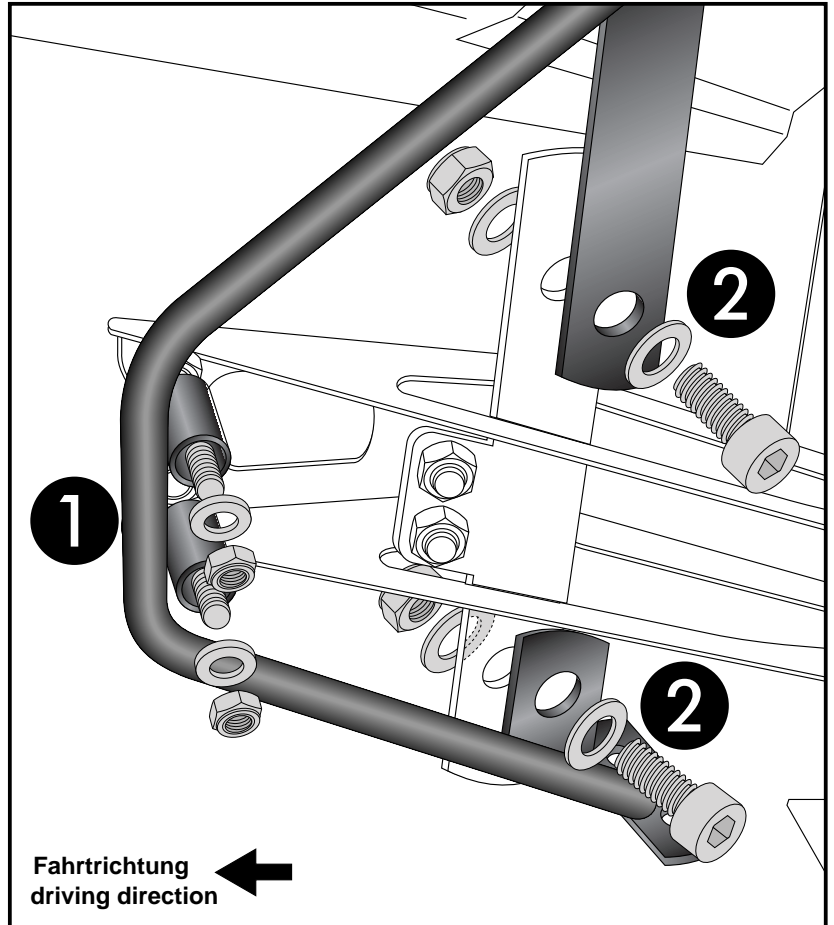

Montage C-Bow Halter vorne links/rechts:

Die Originalschrauben der Soziusfußrastenhalterung entfernen, diese entfallen. Die Halter zwischen Fußraste und Rahmen mit den Inbusschrauben M8x40 und U-Scheiben ø8,4 verschrauben. Zwischen Halter und Rahmen die Aludistanz Ø25xØ9x5mm fügen.

Die Distanzen entfallen bei gemeinsamer Montage mit Minirack oder Alu/Easyrack.

Fastening of the front adapters left+right:

Dismantle the original screws of the footrest holders. Screws are obsolete. The frontadapters will be fixed between frame and footrest holder. Use allen screws M8x40 with washers ø8,4. Add alu spacer Ø25xØ9x5mm between frame and adapter.

Spacers are obsolete when mounting together with a Minirack or Alu/Easyrack.

4

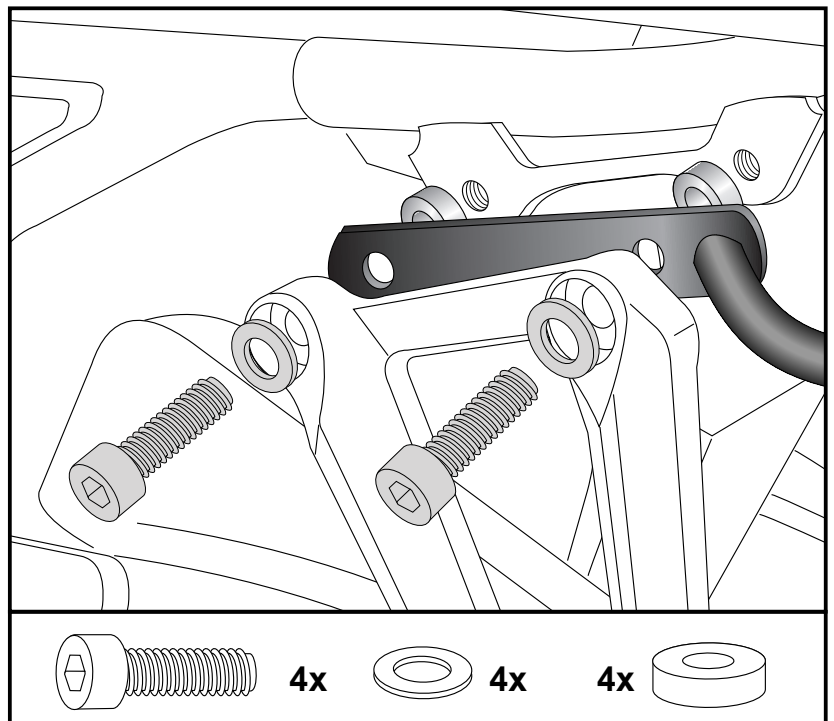

C-Bow Taschenhalter / Soft bag holder

HONDA CB 500 F

ab Baujahr 2016
from date of manufacture 2016

Artikel Nr./Item-no.:

630996 00 05 anthrazit/antracite

HONDA CBR 500 R

ab Baujahr 2016
from date of manufacture 2016

Artikel Nr./Item-no.:

630995 00 05 anthrazit/antracite



DE MONTAGEANLEITUNG
GB MOUNTING INSTRUCTIONS

Montage der C-Bow links + rechts:
An den Adaptern. Dazu die Sechskantschrauben M6x16 und die U-Scheiben Ø6,4 verwenden.

Fastening of the C-Bow:
at the adapters with hexagon bolts M6 x 16 and washers ø6,4.



5

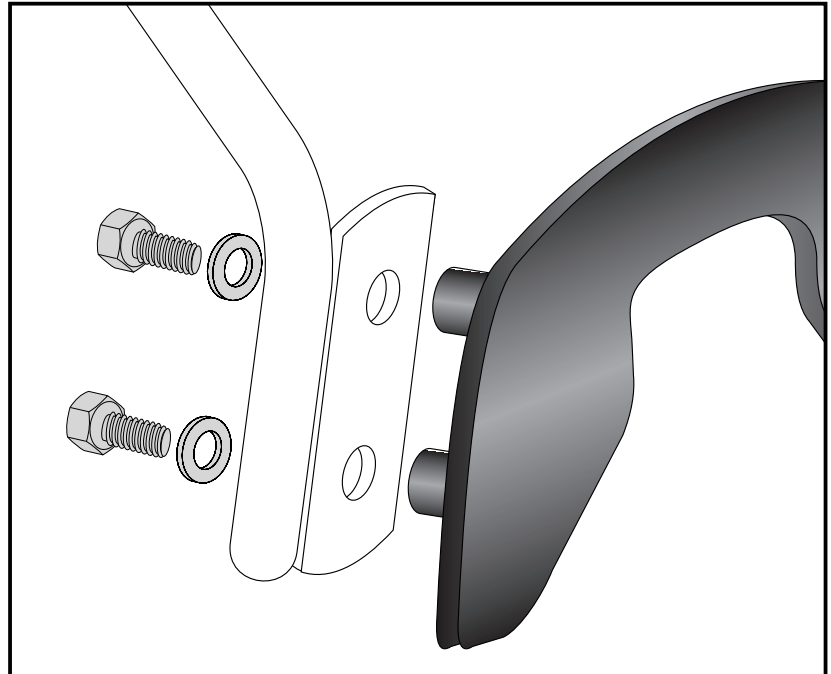

GB ACHTUNG
DE CAUTION

Nach der Montage alle Verschraubungen auf festen Sitz kontrollieren ! Abgebaute Teile wieder montieren. Bitte beachten Sie unsere beigefügten Serviceinformationen.

Control all screw connections after the assembling for tightness! Reassemble the dismantled parts. Please notice our enclosed service information.

Als weiteres Zubehör lieferbar:/ Also available:

Easyrack / Alurack / Sportrack
Motorschutzbügel / Engine guard
Frontschutzbügel / Front guard
Hauptständer / Centre stand
Tankring

Weiteres Zubehör und Artikelnummern auf unsere Homepage.
More accessories and item numbers: see our homepage.



Hepco & Becker GmbH
An der Steinmauer 6
D-66955 Pirmasens
Germany

Tel.: +49 (0)6331 - 1453 - 100
Fax: +49 (0)6331 - 1453 - 120
eMail: vertrieb@hepco-becker.de
www.hepco-becker.de