

BMW C-EVOLUTION '16 -

M O U N T I N G I N S T R U C T I O N S

REF 1769

**WINDSHIELD V-TECH LINE TOURING
(WINDSCREEN INCLUDES DETACHABLE HAND DEFLECTORS)**



OPTION A
WINDSHIELD
WITHOUT
HAND-DEFLECTORS



OPTION B
WINDSHIELD
WITH
HAND-DEFLECTORS



ID	PIEZA/PART	DESCRIPCIÓN	DESCRIPTION	QTY	REF
1		Cúpula touring	Touring screen	1	1769H/WM3
2		Deflector izquierdo	Left deflector	1	1769H/W-IZD
3		Deflector derecho	Right deflector	1	1769H/W-DER
4		Silentblock Ø17 x Ø10 x Ø13 x 10	Ø17 x Ø10 x Ø13 x 10 silentblock	4	AROPASACABLES--
5		Casquillo con valona M5 (negro)	M5 bush with flange (black)	4	CASQUI-----517
6		Tornillo Allen M5x11 Ø11 ISO 7380	M5x11 Ø11 ISO 7380 Allen screw	4	TORNI-AI----520
7		Tornillo Allen M5x16 Ø11 ISO 7380	Allen screw M5x16 Ø11 ISO 7380	4	TORNI-I7380-493
8		Arandela nylon M5x1	M5x1 nylon washer	4	ARNV0000000245
9		Tapón tornillo M5 ISO 7380	M5 ISO 7380 screw cap	4	TAPON-----85
10		Velcro dual lock 25x30mm (se suministra montado con pieza ID2/ID3)	25x30mm dual lock Velcro (supplied already mounted on items 2/3)	2	VELCRO-25X50---
11		Set adhesivos (se suministra montado con pieza ID2/ID3)	Sticker set (supplied already mounted on items 2/3)	1	ADHESI-----260

BMW C-EVOLUTION '16 -

INSTRUCCIONES DE MONTAJE - MOUNTING INSTRUCTIONS - MONTAGEANLEITUNG

1

DISASSEMBLY
DESMONTAJE

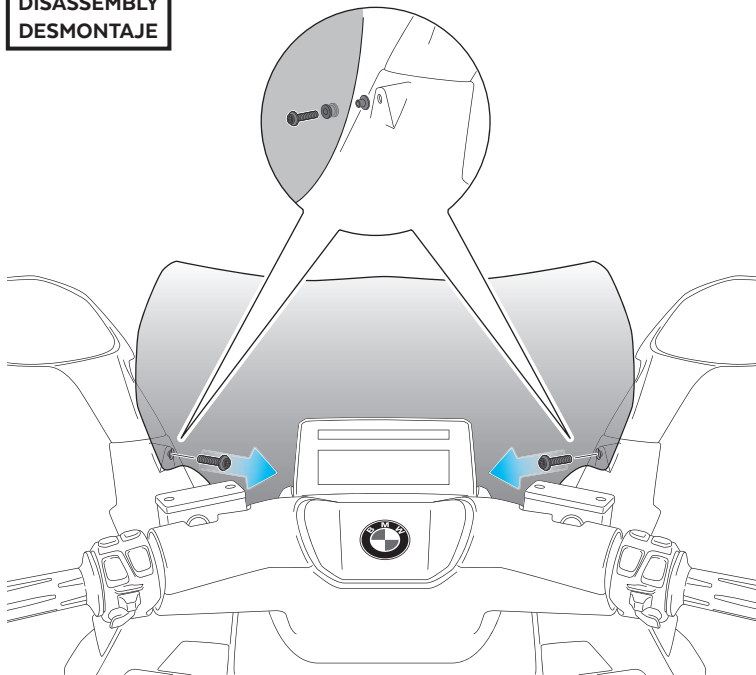

2

DISASSEMBLY
DESMONTAJE

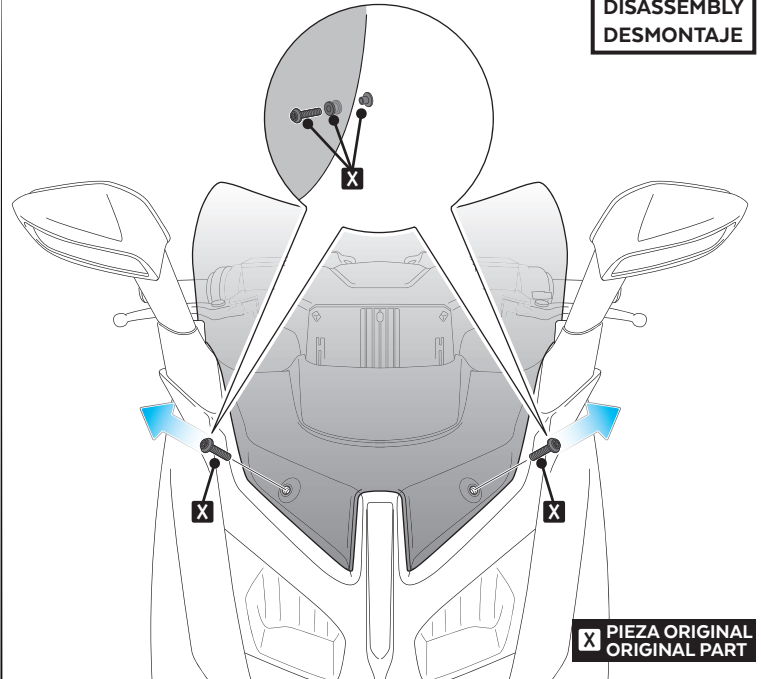

PIEZA ORIGINAL
ORIGINAL PART

3

ASSEMBLY
MONTAJE

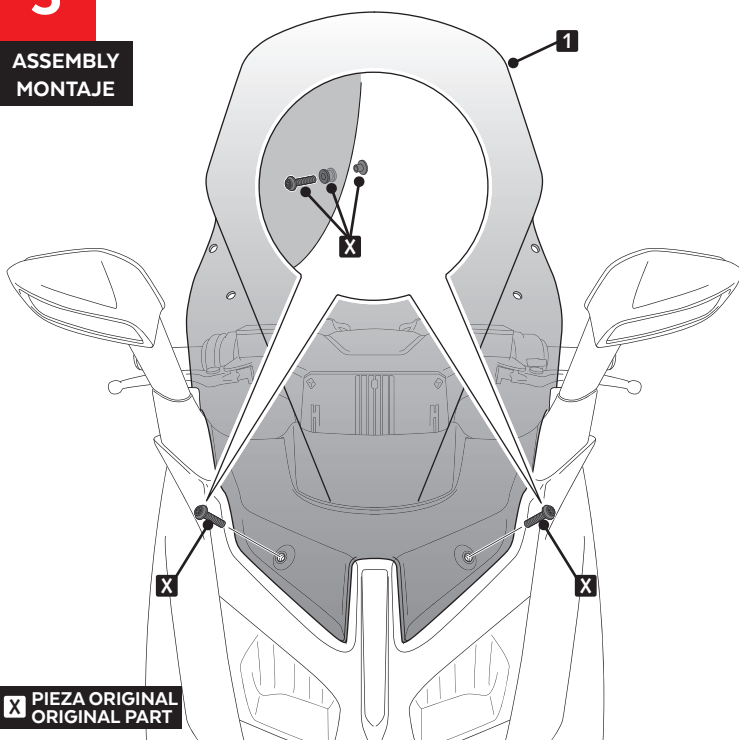

PIEZA ORIGINAL
ORIGINAL PART

4

ASSEMBLY
MONTAJE

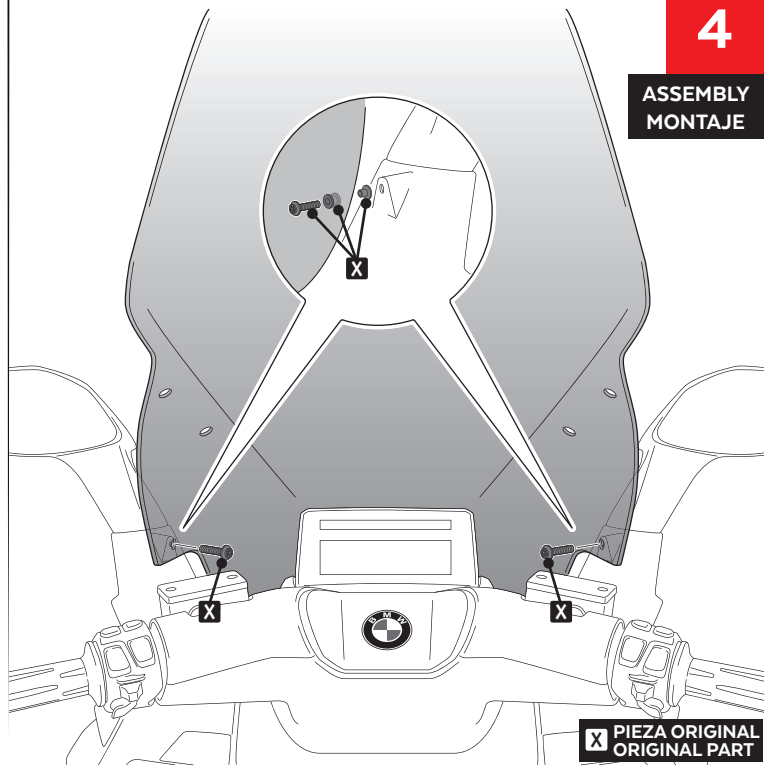

PIEZA ORIGINAL
ORIGINAL PART

BMW C-EVOLUTION '16 -

INSTRUCCIONES DE MONTAJE - MOUNTING INSTRUCTIONS - MONTAGEANLEITUNG

OPTION A

WINDSHIELD
WITHOUT
HAND-DEFLECTORS

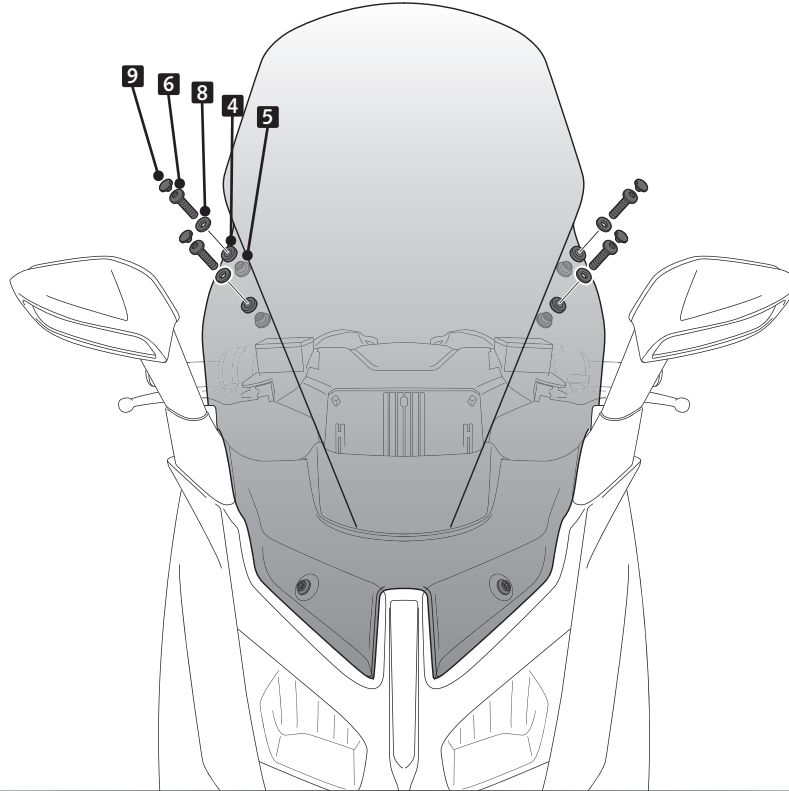

OPTION B

WINDSHIELD
WITH
HAND-DEFLECTORS

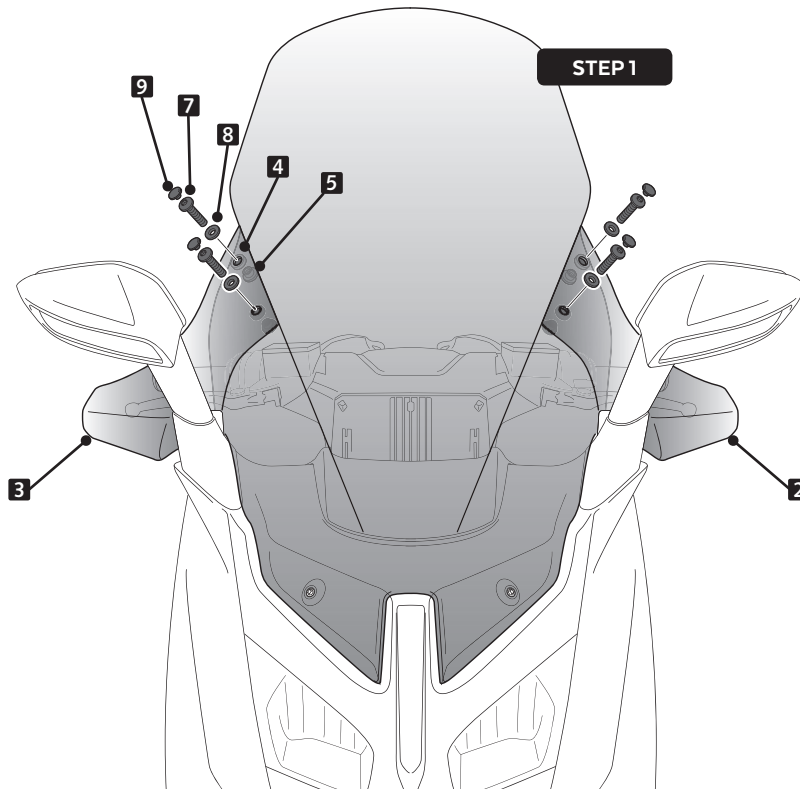

STEP 2

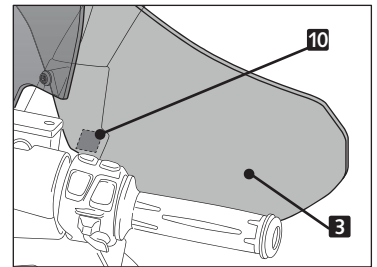

Nota: Extraer papel del adhesivo del velcro (ID 10- se suministra montado en las piezas ID2/3) y posicionar en el retrovisor.

Extract the paper from the velcro (ID-10 supplied already mounted on items ID2/3) and position to rearview.

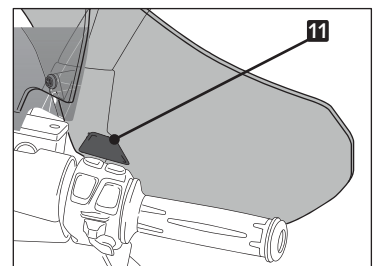

CÚPULA CON BARRA FIJADORA DE POSICIÓN / WINDSCREEN WITH STICK TO HOLD WIDTH



1 Person



5 min



EASY



ALLEN
Nº 4



ID.	PIEZA / PART	DESCRIPCIÓN	DESCRIPTION	QTY.
1		Barra de plástico fijadora de posición que ayuda a mantener la anchura original de la cúpula	Plastic stick to hold shape in order to maintain original width of the windscreen	1
2		Tornillo M6x25 DIN7991	M6x25 DIN7991 screw	2
3		Arandela cónica de plástico Ø20xØ6x5mm	Ø20xØ6x5mm plastic conical washer	2
4		Silentblock M6	M6 silentblock	2

CÚPULA CON BARRA FIJADORA DE POSICIÓN / WINDSCREEN WITH STICK TO HOLD WIDTH

INSTRUCCIONES DE MONTAJE - MOUNTING INSTRUCTIONS - MONTAGEANLEITUNG

1

DISASSEMBLY
DESMONTAJE

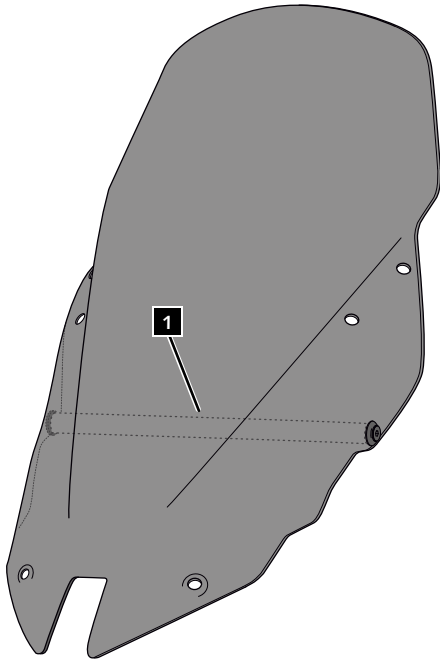

2

DISASSEMBLY
DESMONTAJE

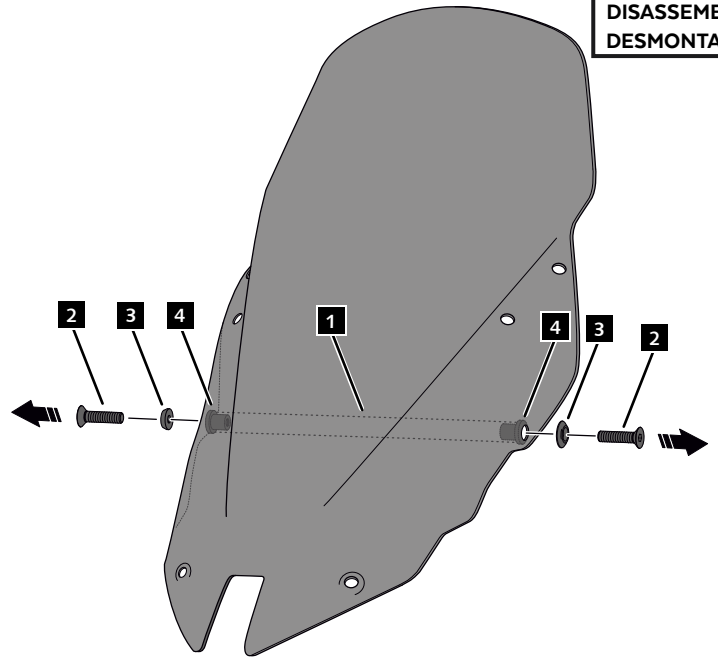

3

DISASSEMBLY
DESMONTAJE

Retirar barra de plástico /
Remove plastic stick

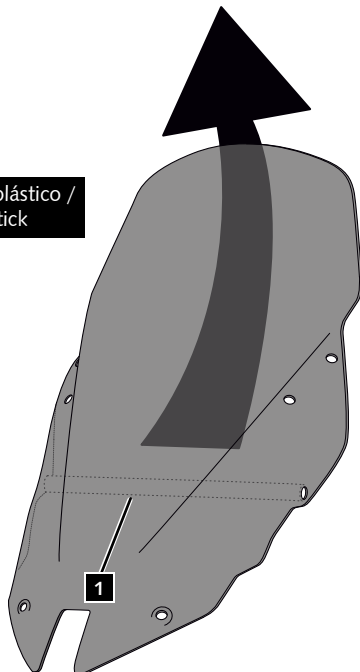

4

DISASSEMBLY
DESMONTAJE

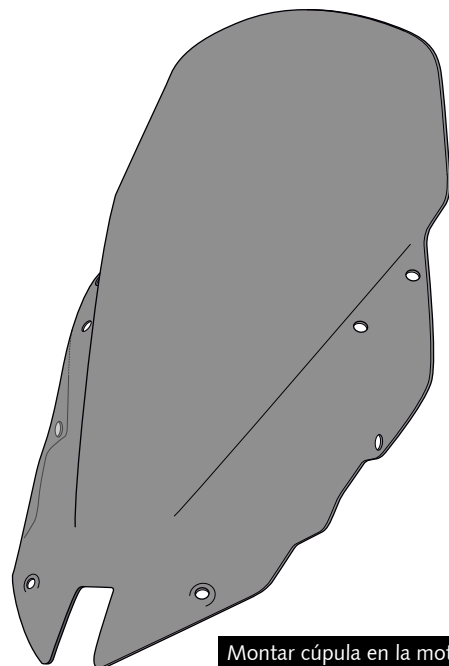

Montar cúpula en la moto /
Mount windscreen on the motorcycle